

# PT9DN (Extended Range)

Heavy Industrial • DeviceNET®

Linear Position/Velocity to 1700 inches (4300 cm)

Stroke Range Options: 0-600 to 0-1700 inches

VLS Option To Prevent Free-Release Damage

IP68 • NEMA 6 Protection

## GENERAL

Full Stroke Range Options (on this datasheet)	0-600 to 0-1700 inches
Electrical Signal Interface	CANbus ISO 11898
Protocol	DeviceNET Version 2.0
Accuracy	± 0.10% full stroke
Repeatability	± 0.02% full stroke
Resolution	± 0.003% full stroke
Measuring Cable	nylon-coated stainless steel
Enclosure Material	powder-painted aluminum or stainless steel
Sensor	plastic-hybrid precision potentiometer
Potentiometer Cycle Life	≥ 250,000 cycles
Maximum Retraction Acceleration	see ordering information
Maximum Velocity	see ordering information
Weight, Aluminum (Stainless Steel) Enclosure	14 lbs. (28 lbs.) max.

## ELECTRICAL

Input Voltage	bus powered
Input Current	40 mA max.
Address Setting/Node ID	0...63 set via DIP switches (default: 63)
Baud Rate	125K, 250K or 500K set via DIP switches
EDS File	available @ <a href="http://celesco.com/downloads">http://celesco.com/downloads</a>

## ENVIRONMENTAL

Enclosure	NEMA 4/4X/6, IP 67
Operating Temperature	-40° to 200°F (-40° to 90°C)
Vibration	up to 10 g to 2000 Hz maximum

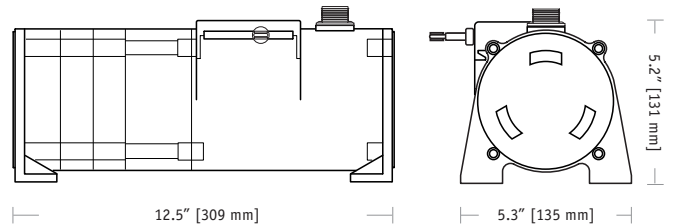
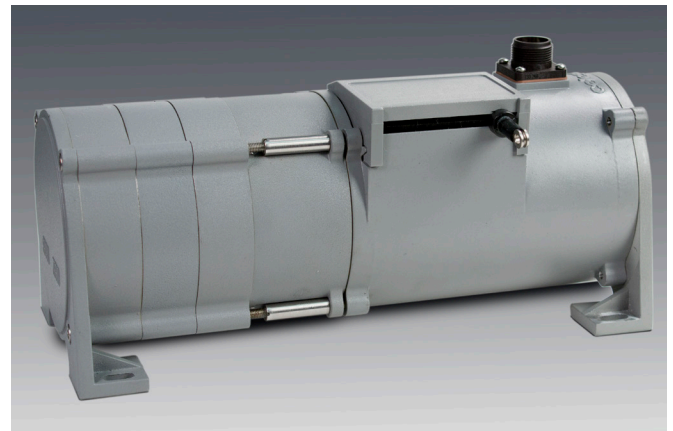

The PT9DN communicates via DeviceNET protocol with programmable controllers in factories and harsh environments requiring linear position measurements in ranges up to 1700".

As a member of our innovative family of NEMA 4 rated cable-extension transducers, the PT9DN installs in minutes by simply mounting it's body to a fixed surface and attaching it's cable to the movable object. Perfect parallel alignment not required.

## Output Signal:

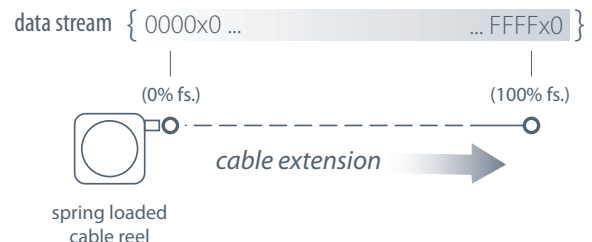

## I/O Format:

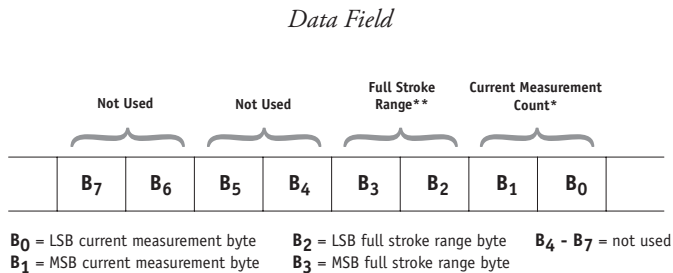
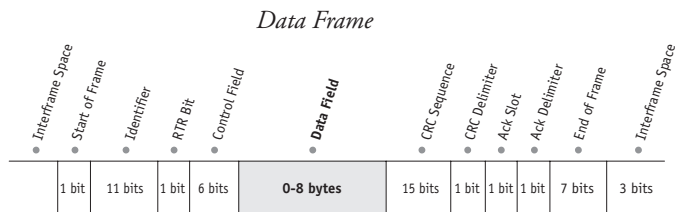

### \*Current Measurement Count

The **Current Measurement Count (CMC)** is the output data that indicates the present position of the measuring cable.

The CMC is a 16-bit value that occupies the first two bytes (B<sub>0</sub> and B<sub>1</sub>) of the data field. B<sub>0</sub> is the LSB (least significant byte) and B<sub>1</sub> is the MSB (most significant byte).

The CMC starts at 0000H with the measuring cable fully retracted and continues upward to the end of the stroke range stopping at FFFFH. This holds true for all ranges.

### \*\*Full Stroke Range

The **Full Stroke Range (FSR)** is a 16-bit value in the data field that expresses the full range of the sensor in inches. This value can be used to convert the actual count to units of measurement should the application require it.

The full stroke measurement range occupies the second two bytes (B<sub>2</sub> and B<sub>3</sub>) of the data field.

B<sub>2</sub> is the LSB (least significant byte) and B<sub>3</sub> is the MSB (most significant byte).

This value is expressed in inches.

Example:

Hex Value	Decimal Equivalent	Full Stroke Range
001E	30	30 inches

### Converting CMC to Inches

If required, the CMC can easily be converted to a linear measurement expressed in inches instead of just counts.

This is accomplished by first dividing the CMC by 65,535 (total counts over the range) and then multiplying that value by the FSR:

$$\left( \frac{\text{CMC}}{65,535} \right) \times \text{FSR}$$

Example:

If the full stroke range is **30 inches** and the current position is **OFF2 Hex (4082 Decimal)** then,

$$\left( \frac{4082}{65,535} \right) \times 30.00 \text{ inches} = 1.87 \text{ inches}$$

## Address Setting (Node ID), Baud Rate and Bus Termination Settings

### Address Setting (Node ID)

The Address Setting (Node ID) is set via 6 switches located on the 8-pole DIP switch found on the DeviceNET controller board located inside the transducer.

The DIP switch settings are binary starting with switch number 1 (= 2<sup>0</sup>) and ending with switch number 6 (= 2<sup>5</sup>).

DIP-1 (2 <sup>0</sup> )	DIP-2 (2 <sup>1</sup> )	DIP-3 (2 <sup>2</sup> )	DIP-4 (2 <sup>3</sup> )	DIP-5 (2 <sup>4</sup> )	DIP-6 (2 <sup>5</sup> )	address (decimal)
0	0	0	0	0	0	0
1	0	0	0	0	0	1
0	1	0	0	0	0	2
...	...	...	...	...	...	...
1	1	1	1	1	1	63



### Baud Rate

The transmission baud rate may be either factory preset at the time of order or set manually at the time of installation.

The baud rate can be set using switches 7 & 8 on the 8-pole DIP switch found on the DeviceNET controller board located inside the transducer.

DIP-7	DIP-8	baud rate
0	0	125k
1	0	250k
0	1	500k
1	1	125k



### Bus Termination

The setting of the internal bus termination resistor may be specified upon order or manually changed by the end user at the time of installation.

The bus termination resistor is activated setting switches 1 & 2 on the 2-pole DIP switch (located on the internal DeviceNET controller board) to the "ON" position.

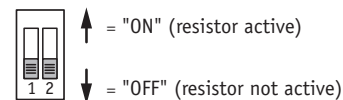

### DeviceNET Controller Board and DIP Switch Location

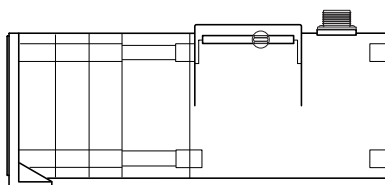
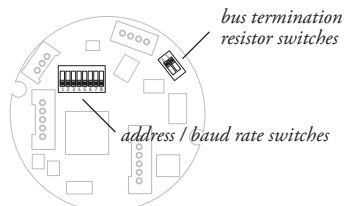

internal dip switches & controller board  
to gain access to the controller board, remove four Allen-Head Screws and remove end cover bracket.

Outline Drawing

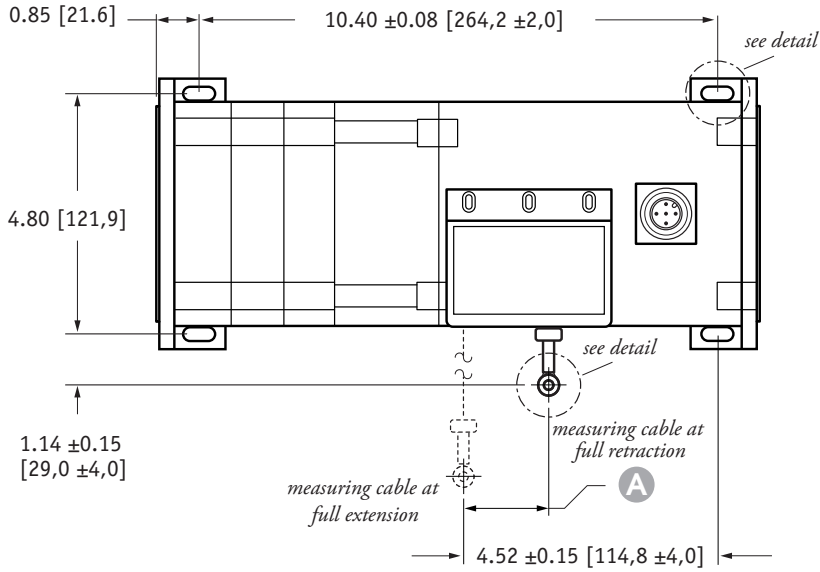

**mounting hole detail**

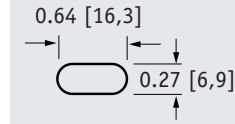

**eyelet detail**

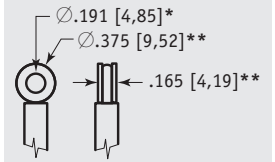

**A DIMENSION**

RANGE	inches [mm]
600	1.76 [44,7]
800	1.58 [40,1]
1000	1.98 [50,2]
1200	1.98 [50,2]
1500	1.86 [47,2]
1700	2.11 [53,6]

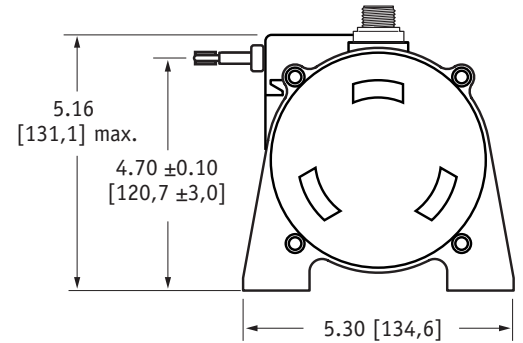
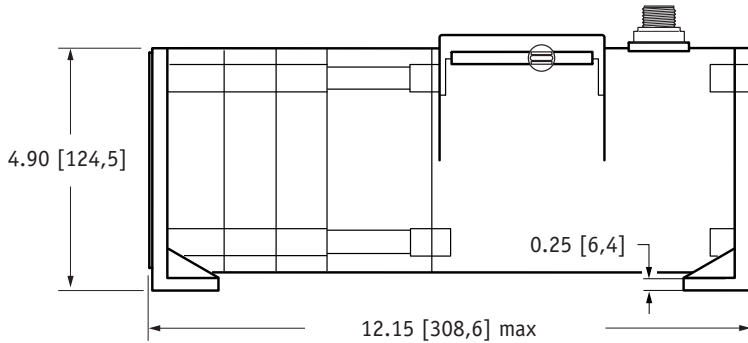

DIMENSIONS ARE IN INCHES [MM]  
tolerances are 0.03 IN. [0.5 MM] unless otherwise noted.

\* tolerance = +.005 - .001 [+ .13 - .03]  
\*\* tolerance = +.005 - .005 [+ .13 - .13]

Ordering Information:

**Model Number:**

**PT9DN** -                                
order code:            **R**        **A**        **B**        **C**        **D**        **E**

Sample Model Number:

**PT9DN - 1200ALFR - 500TRSC5**

- R** range: 1200 (1200 inches)
- A** enclosure: AL (aluminum)
- B** cable exit: FR (front)
- C** baud rate: 500 (500k bits/sec.)
- D** terminating resistor: TR (with terminating resistor)
- E** electrical connection: SC5 (5-meter cordset with straight plug)

**Full Stroke Range:**

<b>R</b> order code:	<b>600</b>	<b>800</b>	<b>1000</b>	<b>1200</b>	<b>1500</b>	<b>1700</b>
full stroke range, min:	600 in.	800 in.	1000 in.	1200 in.	1500 in.	1700 in.
cable tension (±35%):	27 oz.	24 oz.	20 oz.	19 oz.	18 oz.	17 oz.
measuring cable:	.034-in. dia. nylon-coated stainless	.019-in. dia. nylon-coated stainless	.019-in. dia. nylon-coated stainless	.019-in. dia. nylon-coated stainless	.014-in. dia. nylon-coated stainless	.014-in. dia. nylon-coated stainless

Ordering Information (cont.):

**Enclosure Material:**

<b>A</b> order code:	<b>AL</b>	<b>SS</b>
enclosure material:	powder-painted aluminum	303 stainless steel
max. acceleration:	1g	1g
max. velocity:	60 inches/sec.	60 inches/sec.

**Cable Exit:**

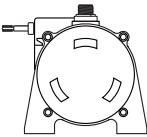
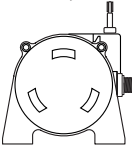
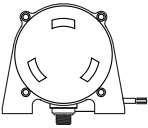
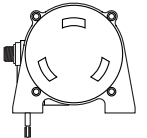
<b>B</b> order code:	<b>FR</b>	<b>UP</b>	<b>BK</b>	<b>DN</b>
	front	top	back	down
				



**Baud Rate:**

<b>C</b> order code:	<b>125</b>	<b>250</b>	<b>500</b>
	125 kbaud	250 kbaud	500 kbaud

**Terminating Resistor:**

<b>D</b> order code:	<b>TR</b>	<b>NR</b>
	terminating resistor	no terminating resistor

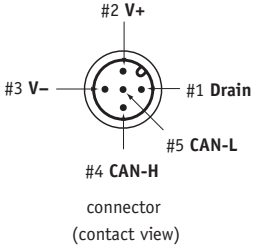
**Electrical Connection:**

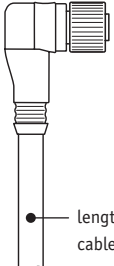
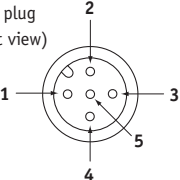
<b>E</b> order code:	<b>blank</b>	<b>MC5</b>	<b>SC5</b>	<b>NC5</b>																		
	5-pin micro-connector <i>(no mating plug supplied)</i>	5-pin micro-connector w/ mating plug	5-pin micro-connector and 5 meter length cordset w/straight mating plug	5-pin micro-connector and 5 meter length cordset w/90° mating plug																		
	 <p>#2 V+ #3 V- #1 Drain #5 CAN-L #4 CAN-H connector (contact view)</p>	 <p>0.16" - 0.32" OD Cable (THIN)</p>	 <p>length: 16ft [5M] cable: Thin</p>	 <p>length: 16ft [5M] cable: Thin</p>																		
		 <p>mating plug (contact view)</p>	<table border="1"> <thead> <tr> <th>pin</th> <th>signal</th> <th>wire color</th> </tr> </thead> <tbody> <tr> <td>1</td> <td>drain</td> <td>brown</td> </tr> <tr> <td>2</td> <td>V+</td> <td>white</td> </tr> <tr> <td>3</td> <td>V-</td> <td>blue</td> </tr> <tr> <td>4</td> <td>Can-H</td> <td>black</td> </tr> <tr> <td>5</td> <td>Can-L</td> <td>grey</td> </tr> </tbody> </table>	pin	signal	wire color	1	drain	brown	2	V+	white	3	V-	blue	4	Can-H	black	5	Can-L	grey	
pin	signal	wire color																				
1	drain	brown																				
2	V+	white																				
3	V-	blue																				
4	Can-H	black																				
5	Can-L	grey																				

version: 9.0 last updated: January 22, 2016