

# Rotational Position Transducer

0/4...20 mA Output • Hazardous Area Certification  
 Ranges: 0-90° to 0-50 Turns  
 Industrial Grade

# RT9420



## Specification Summary:

**GENERAL**  
 Full Stroke Range Options ..... 0-0.125 to 0-50 turns  
 Output Signal Options ..... 4...20 mA (2-wire) and 0...20 mA (3-wire)  
 Accuracy ..... ± 0.30% to ±0.15% full stroke *see ordering information*  
 Repeatability ..... ± 0.05% full stroke  
 Resolution ..... essentially infinite  
 Enclosure Material Options ..... powder-painted aluminum or stainless steel  
 Sensor ..... plastic-hybrid precision potentiometer  
 Potentiometer Cycle Life ..... *see ordering information*  
 Shaft Loading ..... up to 35 lbs. radial and 5 lbs. axial  
 Weight, Aluminum (Stainless Steel) Enclosure ..... 5 lbs. (10 lbs.) max.

**ELECTRICAL**  
 Input Voltage ..... *see ordering information*  
 Input Current ..... 20 mA max.  
 Maximum Loop Resistance (Load) ..... (loop supply voltage - 8)/0.020  
 Circuit Protection ..... 38 mA max.  
 Impedance ..... 100M ohms@100 VDC, min.  
 Output Signal Adjustment  
 Zero Adjustment ..... from factory set zero to 50% of full stroke range  
 Span Adjustment ..... to 50% of factory set span  
 Thermal Effects  
 Zero ..... 0.01% f.s./°F, max.  
 Span ..... 0.01% f.s./°F, max.

**ENVIRONMENTAL**  
 Enclosure ..... NEMA 4/4X/6, IP 67/68  
 Hazardous Area Certification ..... *see ordering information*  
 Operating Temperature ..... -40° to 200°F (-40° to 90°C)  
 Vibration ..... up to 10 G's to 2000 Hz maximum

**EMC COMPLIANCE PER DIRECTIVE 89/336/EEC**  
 Emission/Immunity ..... EN50081-2/EN50082-2

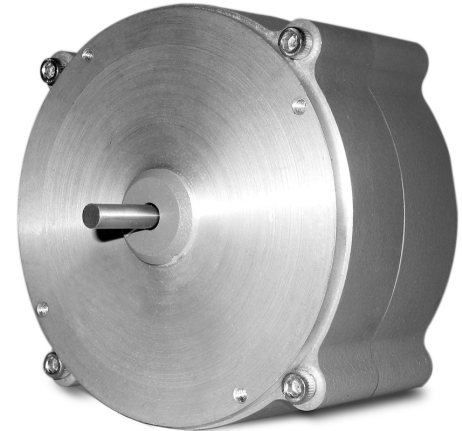

The RT9420 provides rotational position feedback via 4...20 mA current loop signal. This device combines the superb linearity and resolution of a plastic-hybrid potentiometer and the durability of Celesco's 4...20mA circuit to provide an accurate and reliable electrical signal. Additionally the zero and span settings are adjustable through access holes in the housing.

This innovative sensor from Celesco, designed to meet NEMA-4 and IP67 standards, is available in full stroke ranges of 1/4 to 50 turns.

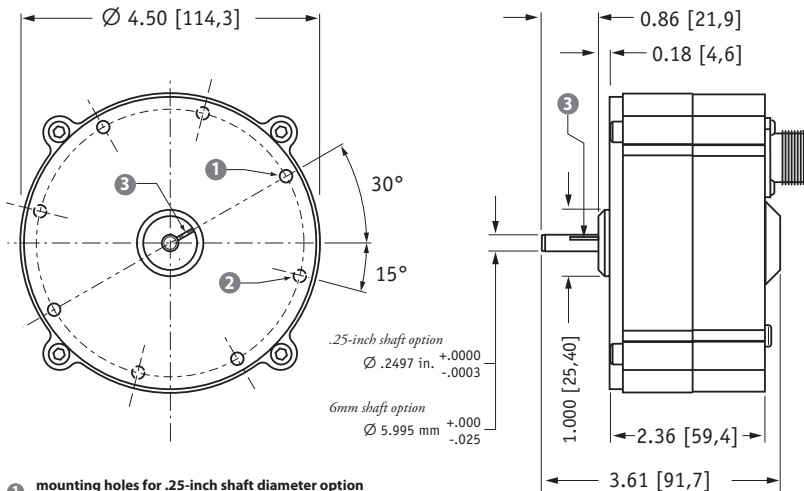

- mounting holes for .25-inch shaft diameter option**  
#8-32 x 0.180 @ 90° apart on a 4.15 in. dia. BC (4 places)
- mounting holes for 6-mm shaft diameter option**  
M4 x 4.5 mm @ 90° apart on a 105.4 mm dia. BC (4 places)
- reference mark**  
full counter-clockwise position - align mark on shaft to mark on face for start of measurement range

ALL DIMENSIONS ARE IN INCHES [MM]

### Output Signal

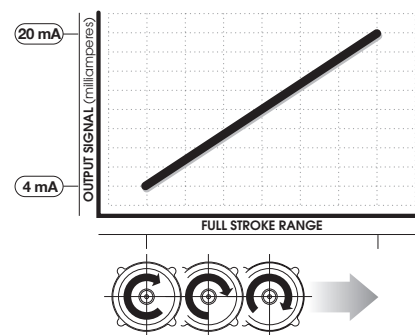



Celesco Transducer Products, Inc.  
 20630 Plummer Street • Chatsworth, CA 91311  
 tel: 800.423.5483 • +1.818.701.2750 • fax: +1.818.701.2799

**celesco**  
 celesco.com • info@celesco.com



**Ordering Information:**

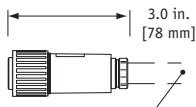
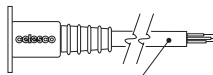
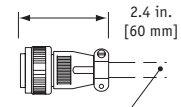

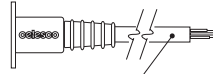
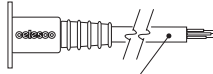
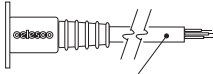
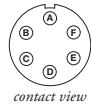

**Electrical Connection:**

<p><b>1</b></p> <p>6-pin plastic connector w/mating plug <b>IP 67, NEMA 4X**, 6</b></p>  <p>3.0 in. [78 mm]</p> <p>1/2 - 5/16" [14 - 8 mm] cable dia. 16 AWG max conductor size connector: MS3102E-14S-6P mating plug: MS3106E-14S-6S</p>	<p><b>2</b></p> <p>10-ft. [3 M] waterproof cable <b>IP 67, NEMA 4X**, 6</b></p>  <p>10 ft. x 0.4-in. dia. [3 M x 10 mm dia.] 18 AWG, type SJTW</p>	<p><b>3</b></p> <p>6-pin metal connector w/mating plug <b>IP 65, NEMA 4</b></p>  <p>2.4 in. [60 mm]</p> <p>3/8-in. [9 mm] max cable dia. 16 AWG max conductor size connector: MS3102E-14S-6P mating plug: MS3106E-14S-6S</p>	<p><b>4</b></p> <p>25-ft. [7.5 M] instrumentation cable <b>IP 67, NEMA 6</b></p>  <p>25 ft. x 0.2-in. dia. [7.5 M x 5 mm dia.] 24 AWG, shielded</p>																											
<p><b>5</b></p> <p>100-ft. [30 M] waterproof cable <b>IP 67, NEMA 4X**, 6</b></p>  <p>100 ft. x 0.4-in. dia. [30 M x 10 mm dia.] 18 AWG, type SJTW</p>	<p><b>6</b></p> <p>10-ft. [3 M] <b>pressure tested*</b> waterproof cable <b>IP 68, NEMA 4X**, 6P</b></p>  <p>10 ft. x 0.4-in. dia. [3 M x 10 mm dia.] 18 AWG, type SJTW</p>	<p><b>7</b></p> <p>100-ft. [30 M] <b>pressure tested*</b> waterproof cable <b>IP 68, NEMA 4X**, 6P</b></p>  <p>100 ft. x 0.4-in. dia. [30 M x 10 mm dia.] 18 AWG, type SJTW</p>																												
<p><b>6-pin Mating Plug</b></p> <table border="1"> <thead> <tr> <th>pin</th> <th>2-wire</th> <th>3-wire</th> </tr> </thead> <tbody> <tr> <td>A</td> <td>8...40 vdc***</td> <td>14...29 vdc common</td> </tr> <tr> <td>B</td> <td>4...20 mA out</td> <td>0...20 mA out</td> </tr> <tr> <td>C</td> <td>-</td> <td>-</td> </tr> <tr> <td>D</td> <td>case ground</td> <td>-</td> </tr> </tbody> </table>  <p>contact view</p>		pin	2-wire	3-wire	A	8...40 vdc***	14...29 vdc common	B	4...20 mA out	0...20 mA out	C	-	-	D	case ground	-	<p><b>Waterproof Cable</b></p> <table border="1"> <thead> <tr> <th>color code</th> <th>2-wire</th> <th>3-wire</th> </tr> </thead> <tbody> <tr> <td>WHITE</td> <td>8...40 vdc***</td> <td>14...29 vdc common</td> </tr> <tr> <td>BLACK</td> <td>4...20 mA out</td> <td>0...20 mA out</td> </tr> <tr> <td>GREEN</td> <td>case ground</td> <td>-</td> </tr> </tbody> </table>		color code	2-wire	3-wire	WHITE	8...40 vdc***	14...29 vdc common	BLACK	4...20 mA out	0...20 mA out	GREEN	case ground	-
pin	2-wire	3-wire																												
A	8...40 vdc***	14...29 vdc common																												
B	4...20 mA out	0...20 mA out																												
C	-	-																												
D	case ground	-																												
color code	2-wire	3-wire																												
WHITE	8...40 vdc***	14...29 vdc common																												
BLACK	4...20 mA out	0...20 mA out																												
GREEN	case ground	-																												
		<p><b>Instrumentation Cable</b></p> <table border="1"> <thead> <tr> <th>color code</th> <th>2-wire</th> <th>3-wire</th> </tr> </thead> <tbody> <tr> <td>RED</td> <td>8...40 vdc***</td> <td>14...29 vdc common</td> </tr> <tr> <td>BLACK</td> <td>4...20 mA out</td> <td>n/a</td> </tr> <tr> <td>WHITE</td> <td>n/a</td> <td>n/a</td> </tr> <tr> <td>GREEN</td> <td>case ground</td> <td>0...20 mA out</td> </tr> </tbody> </table>		color code	2-wire	3-wire	RED	8...40 vdc***	14...29 vdc common	BLACK	4...20 mA out	n/a	WHITE	n/a	n/a	GREEN	case ground	0...20 mA out												
color code	2-wire	3-wire																												
RED	8...40 vdc***	14...29 vdc common																												
BLACK	4...20 mA out	n/a																												
WHITE	n/a	n/a																												
GREEN	case ground	0...20 mA out																												

Notes: { \* -Test pressure: 100 feet [30 meters] H<sub>2</sub>O (40 PSID); Test Medium: Air; Duration: 2 hours.  
\*\* -NEMA 4X applies to stainless steel enclosure only.  
\*\*\* -14-32 VDC for hazardous area option.

**Output Signal Selection:**

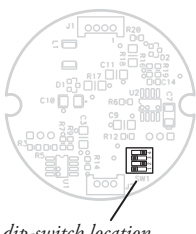
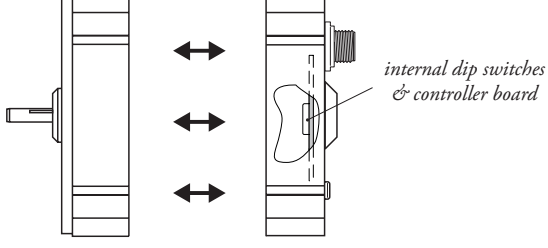
The output signal direction can be reversed at any time by simply changing the dip-switch settings found on the internal signal board. After the settings have been changed, adjustment of the Zero and Span trimpots will be required to precisely match signal values to the beginning and end points of the stroke.

output signal	switch setting	signal board	
<p>0...20 mA or 4...20 mA</p> 		 <p>dip-switch location</p>	 <p>internal dip switches &amp; controller board</p> <p>To gain access to the signal board, remove four Allen-Head Screws and separate the two case halves.</p>
<p>20...0 mA or 20...4 mA</p> 			

version: 5.0 last updated: May 12, 2010