

RT8CN

0–45° to 0–200 Turns • CANbus J1939

Industrial Grade Rotational Position Sensor
 Absolute Rotary Position up to 200 turns
 Aluminum or Stainless Steel Enclosure Options
 IP68 / NEMA 6

GENERAL

Full Stroke Range Options	0-0.125 to 0-200 turns
Electrical Interface	CANbus SAE J1939
Protocol	Proprietary B
Accuracy	see ordering information
Repeatability	± 0.05% full stroke
Resolution	essentially infinite
Enclosure Material Options	powder-painted aluminum or stainless steel
Sensor	plastic-hybrid precision potentiometer
Potentiometer Cycle Life	see ordering information
Shaft Loading	up to 10 lbs. radial and 5 lbs. axial
Starting Torque (25°C)	2.0 in.-oz., max.
Weight, Aluminum (Stainless Steel) Enclosure	3 lbs. (6 lbs.) max.

ELECTRICAL

Input Voltage	see ordering information
Input Voltage	7 - 18 VDC
Input Current	60 mA max.
Address Setting (Node ID)	0...63 set via DIP Switches
Baud Rate	125K, 250K or 500K set via DIP Switches
Update Rate	10 ms. (20 ms. available—contact factory)
Thermal Effects, Span	0.01% f.s./°F, max.

ENVIRONMENTAL

Enclosure	NEMA 4/4X/6, IP 67/68
Operating Temperature	-40° to 200°F (-40° to 90°C)
Vibration	up to 10 g to 2000 Hz maximum

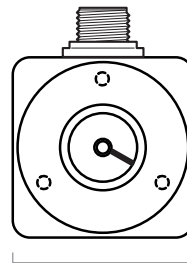

2.5" [64 mm]

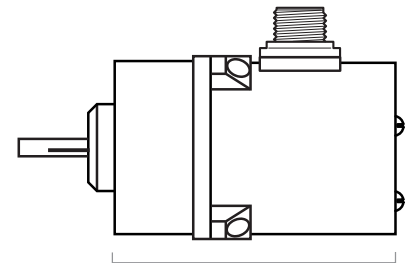

4.0" [102 mm]

Our model RT8CN communicates rotational position feedback to your PLC via the CANbus SAE J1939 interface. The heart of this sensor is a precision plastic-hybrid position potentiometer which provides a “absolute” position and does not ever have to be reset to a “home” position after a power loss or planned shutdown.

This innovative sensor is designed to meet tough NEMA-4 and IP67 environmental standards and is available in full-stroke measurement ranges of 1/8 to 200 turns.

Output Signal:

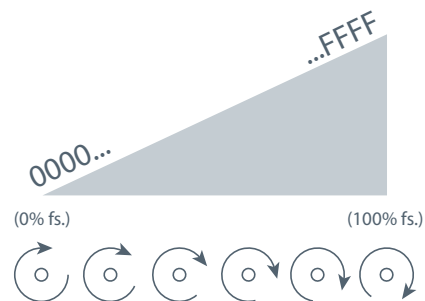

20630 Plummer Street • Chatsworth, CA 91311
 tel: 800.423.5483 • +1.818.701.2750 • fax: +1.818.701.2799



celesco.com • info@celesco.com

Ordering Information (cont.):

Mounting Style:

ⓐ order code:

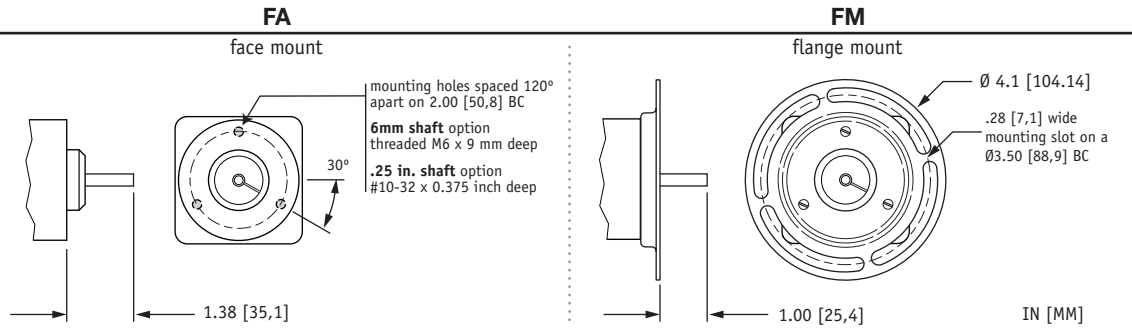

Baud Rate:

ⓑ order code:

125	250	500
125 kbaud	250 kbaud	500 kbaud

Node ID:

ⓒ order code:

0 1 2 ... 62 63

select address (0 - 63 Decimal)

Electrical Connection:

ⓓ order code:

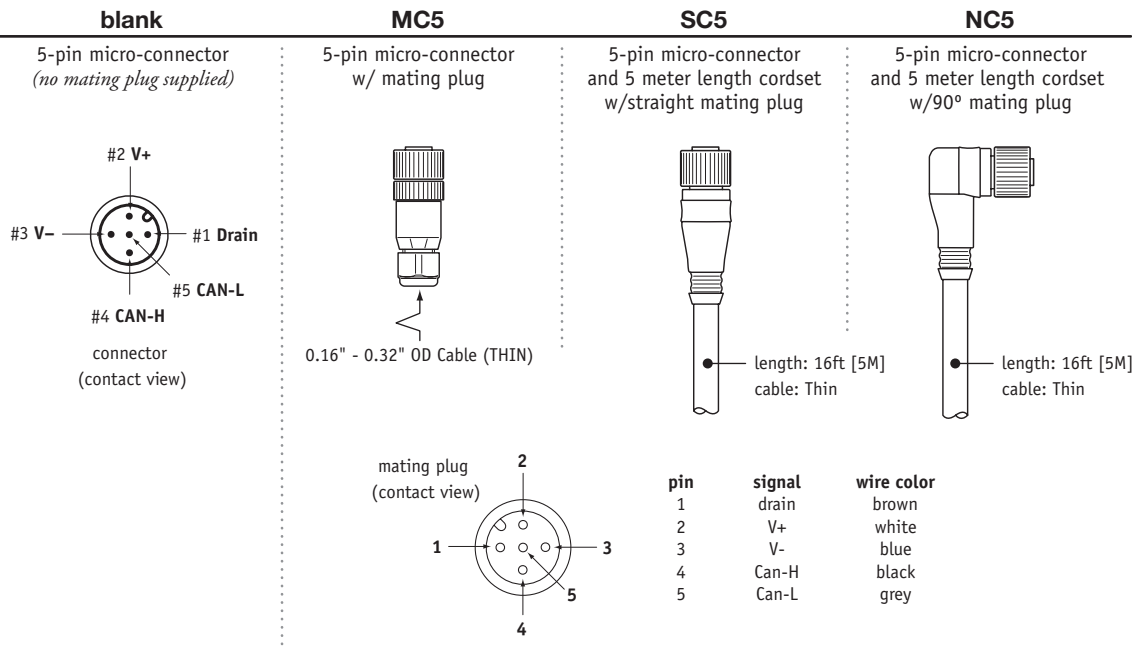

I/O Format and Settings

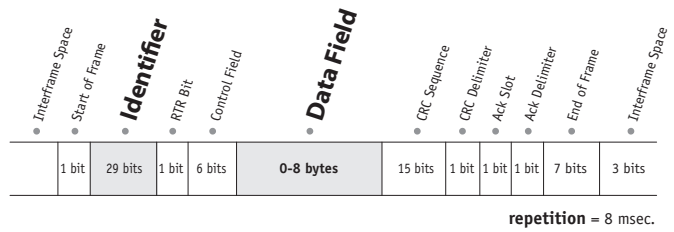

• Identifier

	Message Priority				Future Use		J1939 Reference Proprietary B								Data Field Type*				Not Used		Node ID**									
Example	1	0	0	0	0	0	1	1	1	1	1	1	1	1	0	1	0	1	0	0	1	1	0	0	1	1	1	1	1	1
Identifier Bit No.	28	27	26	25	24	23	22	21	20	19	18	17	16	15	14	13	12	11	10	9	8	7	6	5	4	3	2	1	0	
Hex Value	0				F		F		5				3				3		F											

*Sensor field data can be factory set to customer specific value. **Customer defined, set via Dips 1-6. Bit values shown for example only, see **Address Setting** below.

• Data Field

B₀ = LSB current % of measurement range byte
B₁ = MSB current % of measurement range byte
B₂ = LSB current measurement count byte
B₃ = MSB current measurement count byte

B₄ = error flag
B₅ = error flag
B₆ = LSB velocity data byte
B₇ = MSB velocity data byte

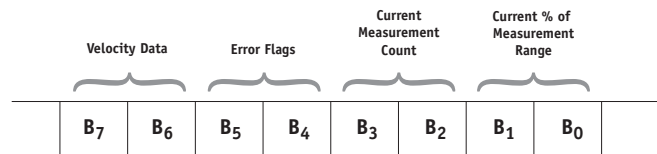

B ₇	B ₆	B ₅	B ₄	B ₃	B ₂	B ₁	B ₀
----------------	----------------	----------------	----------------	----------------	----------------	----------------	----------------

Current Measurement Count

The **Current Measurement Count (CMC)** is the output data that indicates the present position of the measuring cable. The CMC is a 16-bit value that occupies bytes **B₂** and **B₃** of the data field. **B₂** is the **LSB** (least significant byte) and **B₃** is the **MSB** (most significant byte).

The **CMC** starts at **0x0000** with the shaft in the full counter-clockwise position (at reference mark) and continues upward to the end of the stroke range stopping at **0xFFFF**. This holds true for all ranges.

Converting CMC to Degrees

If required, the CMC can easily be converted a rotary measurement expressed in degrees instead of simply counts.

This is accomplished by first dividing the CMC by 65,535 (total counts over the range) and then multiplying that value by the FSR:

$$\left(\frac{\text{CMC}}{65,535} \right) \times \text{FSR}$$

Example:

If the full stroke range is **1 turn (360 degrees)** and the current position is **0x0FF2** (4082 Decimal) then,

$$\left(\frac{4082}{65,535} \right) \times 360 \text{ degrees} = 22.4 \text{ degrees}$$

B ₇	B ₆	B ₅	B ₄	B ₃	B ₂	B ₁	B ₀
----------------	----------------	----------------	----------------	----------------	----------------	----------------	----------------

Current % of Measurement Range

The **Current % of Measurement Range** is a 2-byte value that expresses the current linear position as a percentage of the entire full stroke range. Resolution is **.1 %** of the full stroke measurement range.

This value starts at **0x0000** at the beginning of the stroke and ends at **0x03E8**.

Example:

Hex	Decimal	Percent
0000	0000	0.0%
0001	0001	0.1%
0002	0002	0.2%
...
03E8	1000	100.0%

B ₇	B ₆	B ₅	B ₄	B ₃	B ₂	B ₁	B ₀
----------------	----------------	----------------	----------------	----------------	----------------	----------------	----------------

Error Flags

0x55 (yellow LED on controller board) indicates that the sensor has begun to travel beyond the calibrated range of the internal position potentiometer.

0xAA (red LED on controller board) indicates that the sensor has moved well beyond the calibrated range of the internal position potentiometer.

If either error flag occurs within the full stroke range of the sensor, the unit should be returned to the factory for repair and recalibration.

B ₇	B ₆	B ₅	B ₄	B ₃	B ₂	B ₁	B ₀
----------------	----------------	----------------	----------------	----------------	----------------	----------------	----------------

Velocity

Data in bytes **B₇** - **B₆** is the change and direction of the **CMC** (current measurement count) over a 100 msec time period. This data can then be used to calculate velocity and direction in a post processing operation.

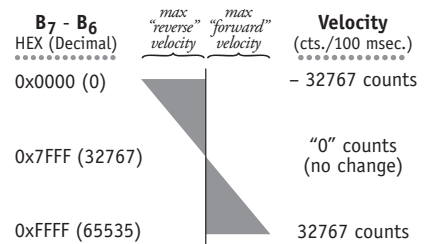

Velocity Calculation

$$\left(\frac{\text{count change} - 32767}{.1 \text{ sec. time period}} \right) \times \left(\frac{\text{full stroke range}}{65,535} \right)$$

Sample Calculations

Clockwise Shaft Rotation (positive direction):

B₇-B₆ = 0x89C6 (43462 Dec.), **full stroke = 1 Turn**

$$\left(\frac{35270 - 32767}{.1 \text{ sec}} \right) \times \left(\frac{1 \text{ Turn}}{65,535} \right) = .38 \text{ turns/sec.}$$

Counter-Clockwise Shaft Rotation (negative direction):

B₇-B₆ = 0x61A8 (25000 Dec.), **full stroke = 1 Turn**

$$\left(\frac{25000 - 32767}{.1 \text{ sec}} \right) \times \left(\frac{1 \text{ Turn}}{65,535} \right) = -1.2 \text{ turns/sec.}$$

Setting the Address (Node ID) and Baud Rate

Address Setting (Node ID)

The Address Setting (Node ID) is set via 6 switches located on the 8-pole DIP switch found on the DeviceNET controller board located inside the transducer.

The DIP switch settings are binary starting with switch number **1** (= 2^0) and ending with switch number **6** (= 2^5).

DIP-1 (2^0)	DIP-2 (2^1)	DIP-3 (2^2)	DIP-4 (2^3)	DIP-5 (2^4)	DIP-6 (2^5)	address (decimal)
0	0	0	0	0	0	0
1	0	0	0	0	0	1
0	1	0	0	0	0	2
...
1	1	1	1	1	1	63

Baud Rate

The transmission baud rate may be either factory preset at the time of order or set manually at the time of installation.

The baud rate can be set using switches **7 & 8** on the 8-pole DIP switch found on the DeviceNET controller board located inside the transducer.

DIP-7	DIP-8	baud rate
0	0	125k
1	0	250k
0	1	500k
1	1	125k



CANBus Controller Board

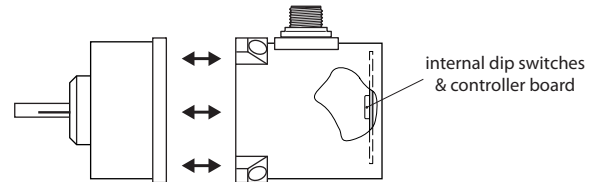
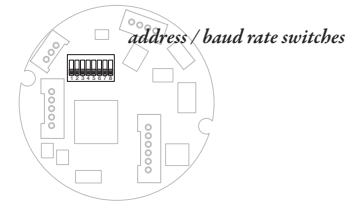

to gain access to the controller board,
remove four Allen-Head Screws and
separate case halves



version: 10.0 last updated: February 28, 2014